

Brown Gas Generator by Transmutation of H₂O with Femto-H₂ based on Cold Fusion (Brown Gas is a Mixture of Hydrogen, Oxygen, and Helium-3)

Noriyuki Kodama
Independent Researcher

Abstract:- Cold fusion is caused by the fusion of femto-D₂ created at the nano-roughness on the surface and Cold Fusion at grain-boundary improve the efficiency by segregation of D at grain boundary. On the sidewall of grain boundary, There are large number of expandable T site, which center is negatively charged and attract D⁺ at grain boundary space. At expandable T site D transition to D⁻ which attract D⁺ and D⁺ combines with D⁻ to be D₂ molecule. Compression of D₂ at expanded T site by metal atoms transition electron of n=1 to deep orbit, which is at a few femto meters from nucleus. Because the electron density between d-d is so high that it can shield the coulomb repulsive force to cause Cold Fusion. Thus created D₂ molecule which covalent electron is deep orbit is called femto-D₂ molecule. Because femto-D₂ is neutral it can fuse to the target element and transmute target element. Thus, this transmutation experiment will verify the mechanism of Cold Fusion based on femto-D₂, however we have issue of transmutation experiment with femto-D₂ because this experiment shows that d is constituted by two protons and one internal electron, which is contrary to the current nuclear model. Therefore, I proposed the transmutation experiment with femto-H₂, and I discovered that helium-3 can be produced by the reaction of “p+femto-H₂ =³Li=³He (electron capture)”, which can be done by H₂O electrolyzer.

I studied the possibility of transmutation of H₂O in H₂O electrolyzer, and found the brown gas and I presume that brown gas must be a mixture of hydrogen, oxygen-16, Oxygen-18, and helium-3 by the transmutation of H₂O with femto-H₂ by the fusion of femto-H₂ to H nucleus(proton) and oxygen nucleus.

The brown gas which is mixed gas of hydrogen oxygen and helium-3 can explain the improved combustion characteristics.

Therefore, I would like to propose the development of transmutation reactor with femto-H₂ based on Cold Fusion mechanism. It is important to increase the probability of collision of femto-H₂ to the H(proton) of H₂O, because femto-H₂ is very small. Thus, I would like

to propose the vibration and motion of H₂O which is perpendicular to the femto-H₂ trajectory.

High-speed H₂O flow from down to top can move H₂O perpendicular to the lateral motion of femto-H₂ just after the ejection with less downward speed.

Because of the improved heat generation efficiency of brown's gas, brown's gas will be used to generate electric power, and can be used for water powered hydrogen car. Therefore, proper transmutation reactor is needed for them. For the electric power generation, oxygen hydrogen combustion turbine power generation system is being developed and Hydrogen Separation system is available. Therefore, I would like to propose the conceptualized hydrogen turbine system to separate and collect helium-3 and hydrogen and they will be mixed to the generated brown gas to maximize the combustion characteristics.

If the helium-3 is collected, total amount of helium-3 can be very large, and it will be used for quantum computer, fuel of plasma fusion or hopefully helium-3 will replace the depleting helium-4.

Keywords:- Brown's Gas, HHO Transmutation Cold Fusion, Femto-H₂, Femto-D₂, Oxygen Hydrogen Combustion Turbine Power Generation System

I. INTRODUCTION

As for plasma nuclear fusion, 3He-D plasma nuclear fusion is being developed, and in order to secure Helium-3 for it, US government has a plan to build a moon base to collect helium-3 to transport to the earth from moon base.

Also, helium-3 is used for cooling quantum computers.

Helium 4 is being depleted on the earth. Helium-4 is very important element for semiconductor industry and helium-4 will be used to cool superconducting magnets in linear motors.

Author discovered that helium-3 can be produced by transmutation of H in H₂O with femto-H₂ based on Cold Fusion mechanism.

This transmutation is related with brown gas, and OHMASA gas, HHO gas. A researcher, Yull Brown happened to discover a special gas generated by the electrolysis of water.

He claimed that energy efficiency of more than 100% could be achieved by electrolyzing water to create brown gas and using it as fuel to run a car engine. That oxyhydrogen gas was called Brown's Gas when marketing such devices.

The combustion characteristics of a gas mixture of hydrogen, oxygen, and helium are being studied [1],[2].

Based on this study, adding helium to the mixture of H₂ and O₂ can have improved combustion characteristics.

Because helium-3 has smaller mass than helium-4, it can improve the combustion characteristics are further improved.

The author reported that the current nucleus model is incorrect and correct model is that nucleus is constituted only by proton and internal electron and neutron is a pair of proton and electron in deep orbit in ref [3],[4],[5].

Based on the study of Transmutation by femto-D₂[3], atomic number increases by 4 by the nuclear fusion of femto-D₂ to the target element. Thus d=2, showing that no neutron in d. in ref [4]. However, this experiment has the

issue because it is not clear which model is wrong, the cold fusion model or the nuclear model.

Therefore, I proposed the transmutation experiment by femto-H₂[5]. Based on transmutation with femto-H₂ will show which one is correct (mechanism of Cold fusion with femto-D₂ or nucleus model).

I have found that helium-3 exist is plasma fusion reactor and discovered the mechanism of production of helium-3[6].

Helium-3 is produced by femto-H₂ created on the inner wall of plasma fusion reactor by hydrogen embrittlement [5].

And discovered the way to produce helium-3 by the transmutation of H in H₂O with femto-H₂ by

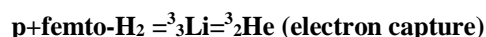

In this report, I would like to show the conceptualized Helium-3 and oxygen-18 production reactor based on femto-H₂ based on Cold Fusion mechanism and it will prove that cold fusion is caused by femto-D₂ fusion, and current nucleus model and neutron model is incorrect.

Therefore, I would like to ask the governments and institutions to develop helium-3 production reactor to verify that femto-H₂ exists and to mass produce helium-3 by transmutation of proton in H₂O because the academic impact and industrial impact are enormous.

II. MECHSNISM OF COLD FUSION

A. Femto-D₂ Molecule Creation at Ezpandable T site

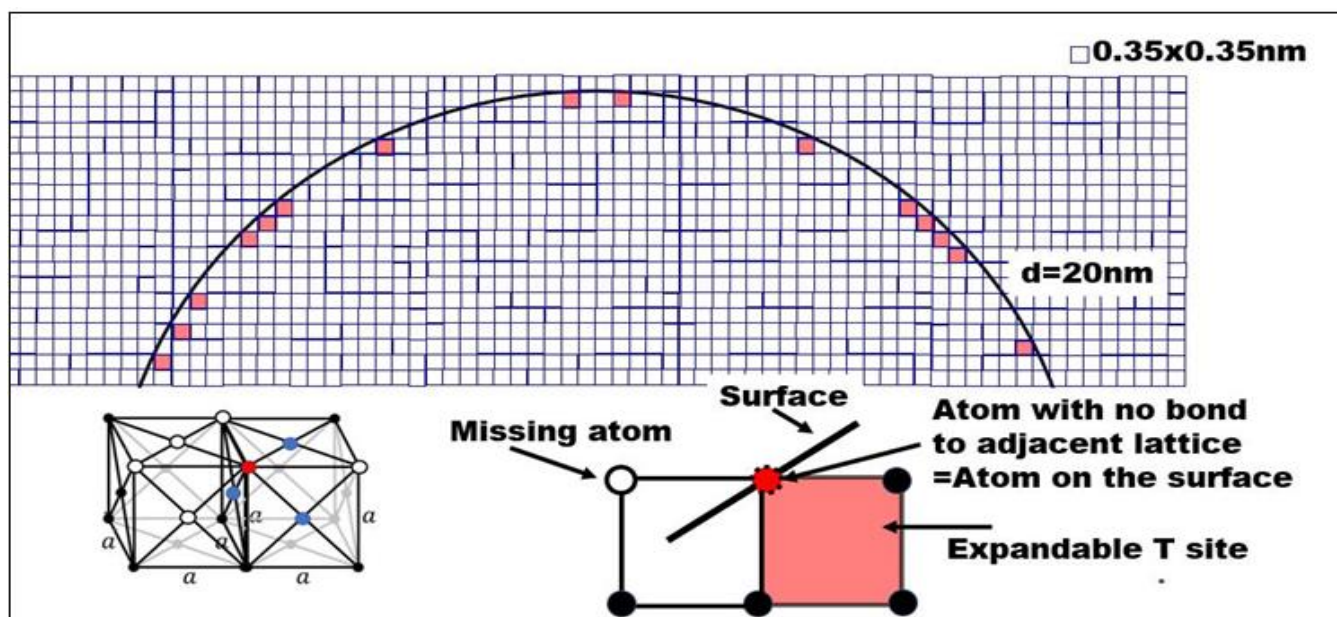

Fig 1 Expandable T site on the Surface with Nano-Roughness

Cold Fusion occurs on the surface with nano-roughness, and feature of the metal space site on the surface with nano-roughness is explained in Fig.1. AS is Fig.1, vertex atom on the surface has no bond to the adjacent atom in the adjacent lattice. Thus, such T site can be expanded.

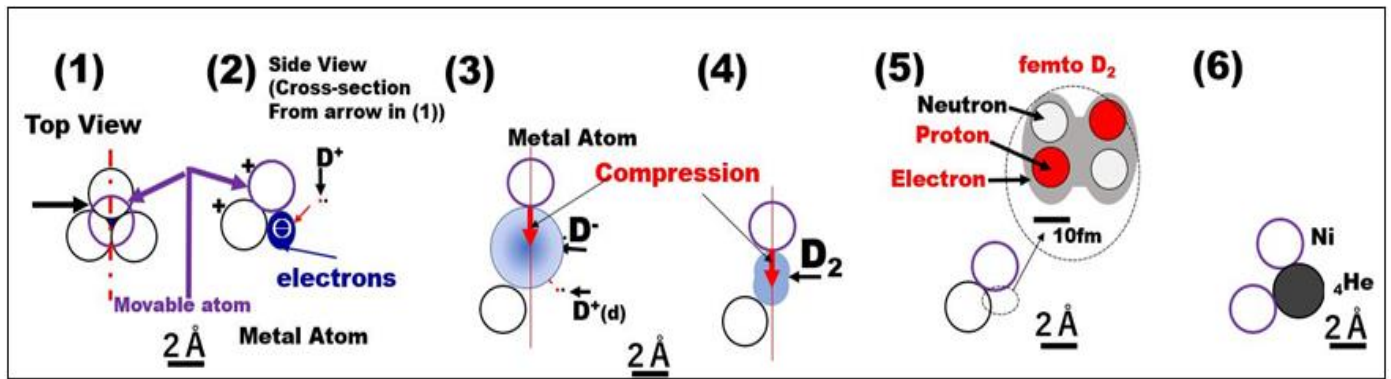

Fig 2 Mechanism of Femto-D₂ Creation and Cold Fusion

Because the center of expandable T site is negatively charged by the emission of electrons by the metal atoms(Fig.2(1)). The negative charge attract D⁺ and D⁺ occupy the expandable T site to be D⁻ ((2)-(3)) and also D attract D⁺ to be D₂ ((3)-(4)). Because covalent bond can be compressed by the atoms of the expanded T site (4), distance between d-d can be reduced, and femto-D₂ is created (5). Femto-D₂ is a hypothetical molecule based on the study of Electron Deep orbit [].

As is shown in Fig.3(5), the electron density between d-d is so dense that it can shield the coulomb repulsive force between d-d, D+D can be fused to be ⁴He (6).

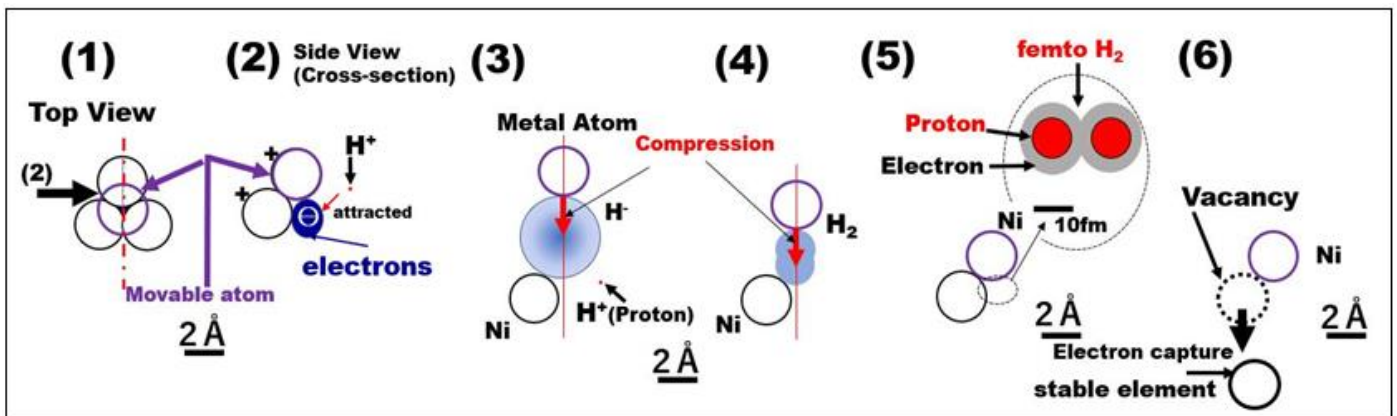

Fig.3 Mechanism of Femto-H₂ Creation and Transmutation

B. Transmutation with Femto-D₂

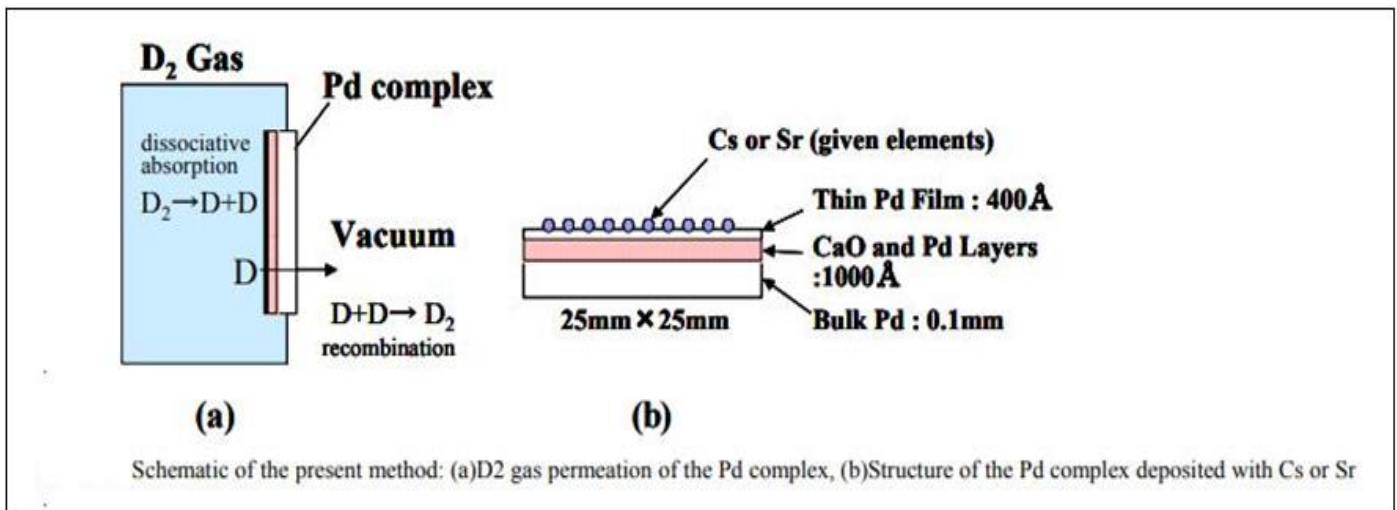

Fig 4 Transmutation Experiment by Iwamura [3]

Transmutation experiment in ref [3] shows that by transmutation with femto-D₂. Note that target element is on the Side, thus it is very difficult for femto-D₂ to reach the femto-D₂ the target element because femto-D₂ descends by the gravity.

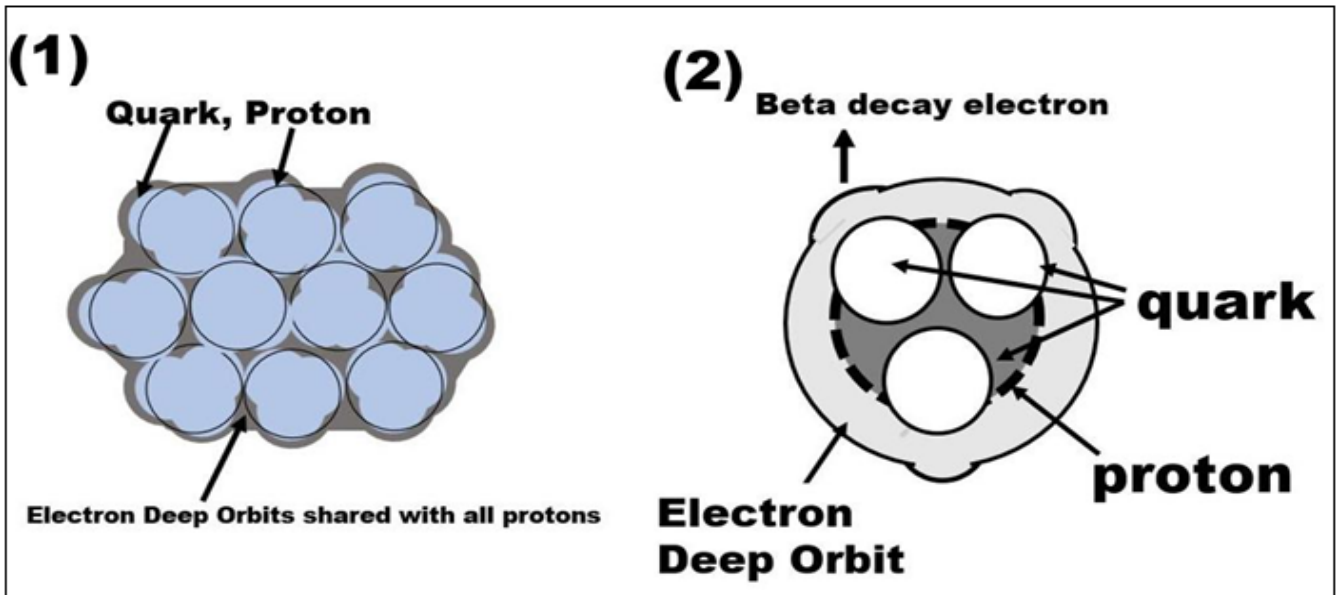

Fig 5 Correct Nucleus Model [4]

In ref [3], Transmutation increases atomic number by 4. Because transmutation adds femto-D₂(two ds) to the target metal indicate that d is 2, constituted only by two protons and one internal electron.

I reported in ref [4] that current nucleus model and neutron model is incorrect, as correct model is shown in Fig.4.

I discovered that nucleus is constituted only by proton and internal electron and neutron is a pair of proton and electron in deep orbit. It is reasonable because this neutron model can explain the beta decay of neutron with very large electron energy distribution due to the shape of proton. Electron orbit is instable at the protrusions by quarks, and neutrino hypo is incorrect.

C. Proposition of Transmutation Experiment with Femto-H₂

In ref[5], transmutation with femto-H₂ is clear because femto-H₂ is constituted by two protons.

D. Helium-3 in Plasma Fusion Reactor[6]

I found the report that helium-3 exists in plasma fusion Reactor and Helion energy used herium-3 to have Helium-3-D plasma fusion. I also studied hydrogen embrittlement in ref [5], which shows that transmutation with femto-H₂ causing the high temperature hydrogen embrittlement. As is shown in Fig.3, during the process of metal high temperature hydrogen environment cause embrittlement,

based on the mechanism of Cold Fusion, I presumed that femto-H₂ created at expandable T site of FCC metal can cause transmutation of metal. Therefore, I presumed that helium-3 in plasma fusion is caused by femto-H₂ created by hydrogen embrittlement. Based on the study of Cold Fusion and hydrogen embrittlement, Helium-3 can be created by the following reactions. Note that femto-H₂ adds two protons to the target element.

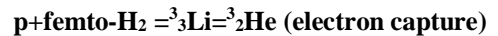

III. CONCEPTUALIZED TRANSMUTATION REACTOR WITH FEMTO-H₂ BY H₂O ELECTROLYZER

A. H₂O Transmutation Reactor with Femto-H₂ with Vertical Metal Electrodes.

Based on the study of helium-3 in plasma fusion reactor I invented the conceptualized transmutation reactor with femto-H₂ to transmute nucleus of H₂O.

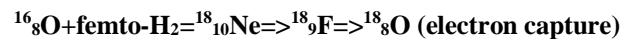
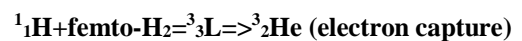

Therefore Helium-3 and oxygen-18 is created by transmutation of H₂O with femto-H₂.

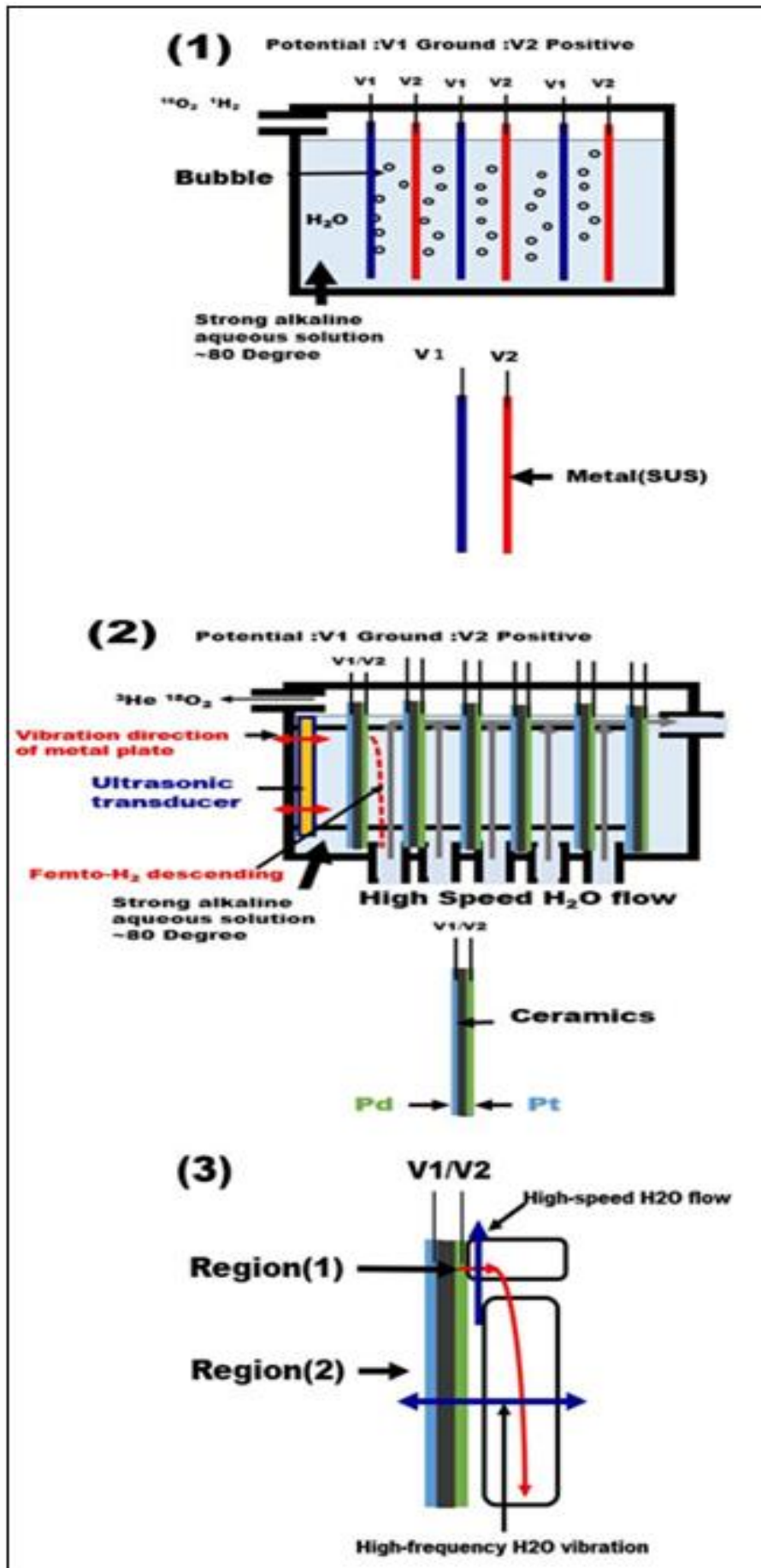

Fig 6 Conceptualized Transmutation Reactor with Femto-H2

- *Conventional electrolyzer of H₂O*
- *Transmutation reactor with femto-H₂*
- *Region of femto-H₂ moves laterally and descending vertically.*

Because the collision probability of femto-H₂ to the nucleus of H(proton) need to be increased, the motion of H₂O is very important.

As is shown in Fig6(1), Conventional electrolyzer of H₂O uses strong alkaline H₂O and metal is SUS with surface corrosion resistance layer. Note that SUS has the FCC grains and so it has the reaction site of Cold Fusion.

Fig6(2) is the conceptualized transmutation reactor based on H₂O electrolyzer. polycrystalline Pd is deposited on the ceramics for a femto-H₂ generation, because the grain-boundary has many expandable T site. Pt is deposited on the other side of ceramics plate for the counter-electrode. Thin polycrystalline Pd layer is for the rapid hydrogen segregation at grain boundary because smaller volume of Pd can increase the concentration of hydrogen rapidly.

AS is explained in Fig. 3 positive Pd voltage is needed for femto-D₂ creation and femto-H₂ creation. Thus, with strong Alkaline H₂O, Pd need to be anode (positive charge), however Pd has been cathode from the start of Cold Fusion in ref [10].

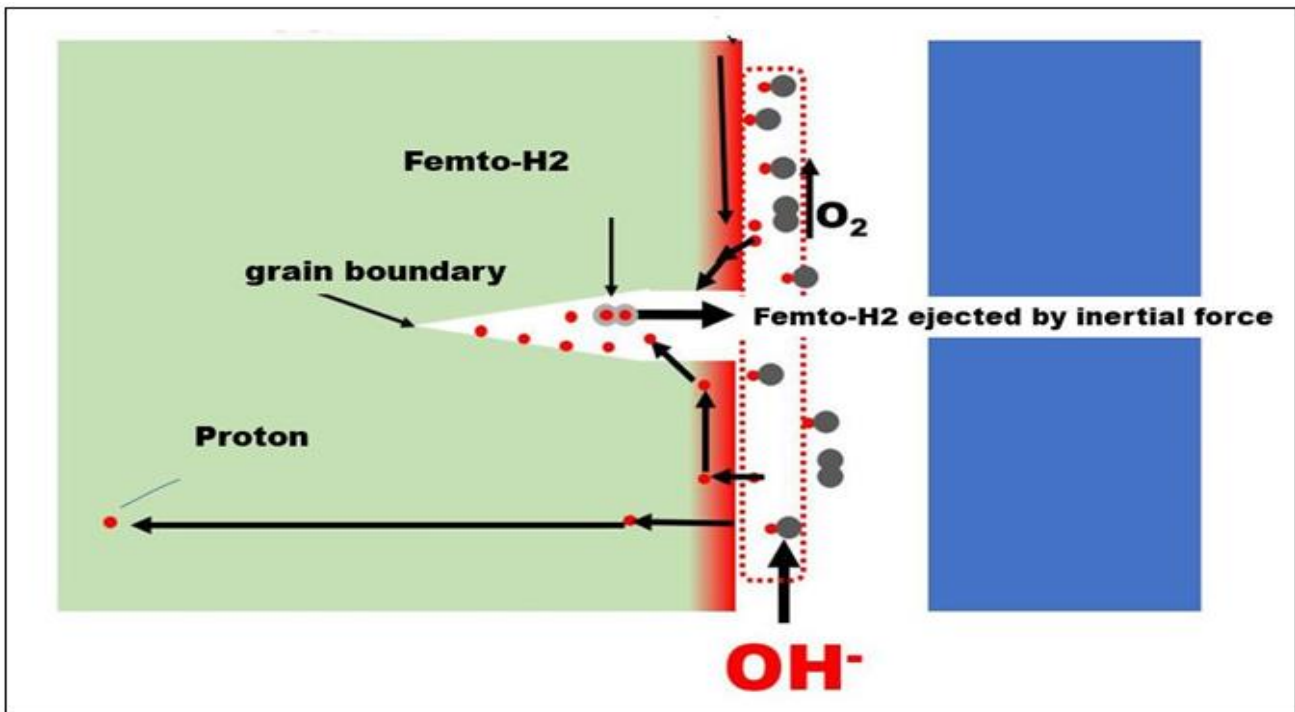

Fig 7 Mechanism of Femto-H₂ Creation at Grain Boundary with Anode in Strong Alkaline H₂O

Fig.7 shows the mechanism of femto-H₂ generation at grain boundary in strong alkaline H₂O. Pd cause Cold Fusion by generating femto-D₂, and in strong alkaline H₂O, OH⁻ carry current between electrodes, and OH⁻ is attracted by the positive metal surface and H⁺ is absorbed in positive metal because H⁺ is smaller than Pd Space Site. With negative voltage H need to be H⁻ and due to its larger size than Pd space site, no H⁻ exists in Pd. Therefore, at the positive voltage of Pd, H⁺ can diffuse rapidly and reach to the grain boundary. Because the space of grain boundary is so narrow, only the H⁺ can exists and the number of H⁺ can be very large due to the smaller size of H⁺(Proton). This is the mechanism of hydrogen segregation and I selected polycrystalline Pd deposition on the ceramics. Another reason to use thin Pd film is the rapid saturation of H⁺ concentration in the metal and it enables the rapid segregation of H⁺ at grain boundary.

Because of the positive voltage of Pd, and because femto-H₂ creation need the positive voltage shown in Fig.3, femto-H₂ can be created rapidly. Therefore, positive voltage of Pd enable the rapid segregation of H₂ at grain boundary and femto-H₂ is created simultaneously. Thus femto-H₂ creation speed is very fast. But note that femti-H₂ descends at the grain boundary, no femto-H₂ ejected from grain boundary in case that metal electrode is set to be vertical as is shown in Fig.7.

Transmutation reactor uses the vibration of metal electrode laterally, which ejects femto-H₂ toward the H₂O between metal electrodes by inertia force.

And vibration improves the probability of transmutation by the motion of H₂O vertical to the trajectory of femto-H₂.

In reg (1) in Fig5(3), femto-H₂ moves laterally due to less gravitational acceleration. For this case H₂O need to move vertically to the lateral motion of femto-H₂. Thus, H₂O flow from bottom to top is needed.

In Reg (2), femto-H₂ descends vertically, then H₂O need to move laterally. This can be done by the vibration of metal electrodes which has H₂O between metal electrodes, and once femto-H₂ ejected by inertia force of metal vibration, trajectory of femto-H₂ trajectory is not affected only by metal vibration.

Thus, H₂O vibrates perpendicular to the direction of descent of femto-H₂.

As is explained in Fig.5(1), conventional H₂O electrolyzer may have the unintentional vibration and H₂O flow, and metal plate may be corrosion-resistant treated SUS which is FCC lattice and has grain boundary which can create femto-H₂. Therefore, brown's gas can be created by the conventional electrolyzer of H₂O.

IV. POWER GENERATION BY BURNING BROWN'S GAS WITH COLLECTION OF HELIUM-3 AND HYDROGEN

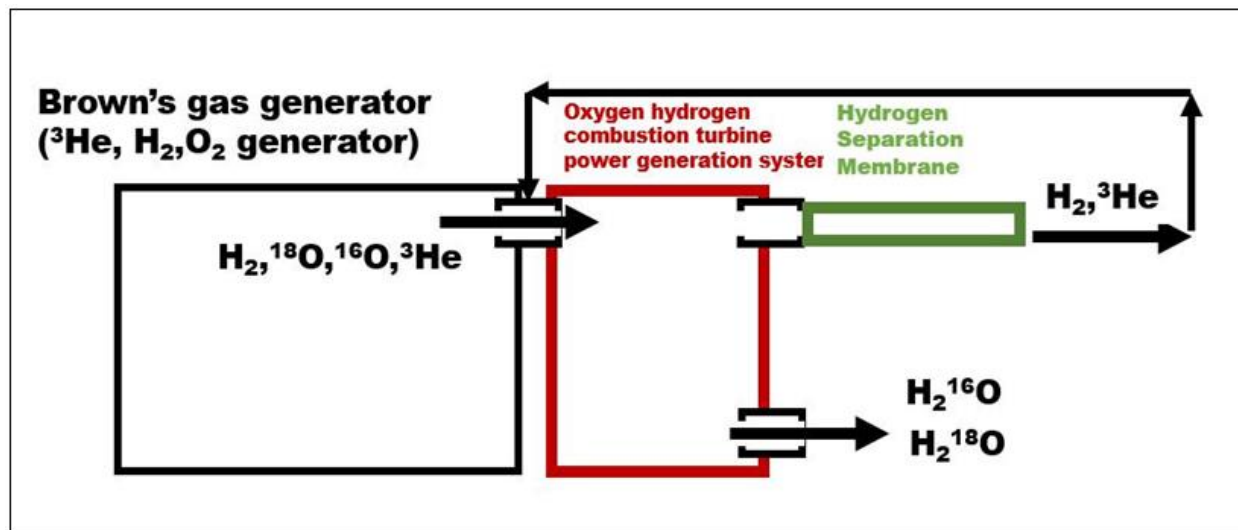

Fig 8 Conceptualized Hydrogen Turbine System to Generate Power and to Collect 3He and ^{16,18}O.

Now a separation membrane module [8] and Oxygen hydrogen combustion turbine power generation system [9] are available.

Thus, they need to combine in Fig.8 to collect ³He and ¹⁸O, and collected ³He is mixed the generated brown gas and they will supplying the brown gas to the turbine to maximize combustion characteristics by adding helium-3.

If the helium-3 is collected, hopefully total amount can be as large as the annual consumption of helium-4 with supplying electric power. This needs the strong support by the governments.

V. VERIFICATION PROPOSAL BY GOVERNMENT AND INSTITUTIONS

Because the impact of Cold Fusion mechanism is enormous academically and industrially, I would like to ask governments and institutions to verify this transmutation experiment that femto-H₂ can create helium-3. If femto-H₂ model is correct, Cold Fusion is caused by femto-D₂ and plasma fusion reactor has helium-3, and brown's gas is real.

Especially brown's gas can be real free energy and can be used for home power supply and can be used for water powered car.

VI. SUMMARY

The transmutation with femto-H₂ will show that mechanism of Cold Fusion based on femto-D₂ to be fused. Based on the study of helium-3 in plasma fusion reactor and unique combustion characteristics of brown gas can be explained by the mixture of hydrogen oxygen and helium-3, I presume that Cold Fusion is caused by femto-D₂ and current nucleus model in incorrect and neutron is a pair of proton and electron in deep orbit.

Importantly development of transmutation reactor can improve the efficiency of power generation with producing helium-3, Thus I would like governments or institutions to develop this conceptualized transmutation reactor to produce power and helium-3. Separation of Helium-3 is needed for the power generation reactor, and separated helium-3 is added to the brown's gas generated by femto-H₂ reactor its combustion characteristics are further improved, and if helium-3 is separated and collected, total amount of helium-3 generation can be enormous, and which can be a substitute of helium-4 or can be used for cooling down of quantum computing.

Duet to the enormous impact of this conceptualized transmutation reactor, I would like to ask governments and institutions to develop this transmutation reactor with separation of helium-3 to collect helium-3.

REFERENCES

- [1]. Masaya NAKAHARA , Hiroyuki KIDO and Kenshiro NAKASHIMA, Effect of Dilution Gas on Turbulent Burning Velocities of Lean Hydrogen Mixtures, Effect of Dilution Gas on Turbulent Burning Velocities of Lean Hydrogen Mixtures”, Vol.30, No.2 (2005)
https://www.jstage.jst.go.jp/article/hess/30/2/30_58/_article/-char/ja/
- [2]. Masaya NAKAHARA, Shohei NISHIBE, Jun HASHIMOTO and Fumiaki ABE, An Experimental Study on Local Flame Displacement Velocity of Hydrogen-Oxygen-Dilution Gas Premixed Turbulent Flames,
https://www.jstage.jst.go.jp/article/kikaib/78/785/78_785_162/_pdf
- [3]. IWAMURA, T. ITOH, M. SAKANO, S. SAKAI, S. KURIBAYASHI, Low Energy Nuclear Transmutation in Condensed Matter Induced by D2 Gas Permeation Through Pd Complexes: Correlation Between Low Energy Nuclear Transmutation in Condensed Matter Induced by D2 Gas Permeation Through Pd Complexes: Correlation Between Deuterium Flux and Nuclear Products, in Tenth International Conference on Cold Fusion. 2003,
<https://www.lenr-canr.org/acrobat/IwamuraYlowenergyn.pdf>
- [4]. Noriyuki Kodama, Correct Nucleus Model proved by Transmutation experiment with Cold Fusion (Neutron to be Tightly Bound Proton-Electron Pair and Nucleus to be Constituted by Protons and Internal Electrons, and no neutrinos), in International Journal of Innovative Science and Research Technology, Volume 7, Issue 5, May, DOI:
<https://doi.org/10.13140/RG.2.2.26885.93924>
- [5]. Noriyuki Kodama, “Mechanism of hydrogen embrittlement based on Cold Fusion”, Int. J. Eng. Technol. Innov., Volume 8, Issue 4, April, (2023) , DOI: 10.13140/RG.2.2.27130.98240
<http://doi.org/10.13140/RG.2.2.27130.98240>
- [6]. Noriyuki Kodama, Helium-3 Production with Femto-H 2 Based on Cold Fusion Mechanism for Plasma Fusion Reactor, International Journal of Innovative Science and Research Technology , Volume 8, Issue 7, July – 2023 DOI: <https://doi.org/10.5281/zenodo.8307432>
- [7]. Noriyuki Kodama, Correct D2O Cold Fusion Reactor with Strong Alkaline Electrolyte(Heat Generating Metal Needs to be Anode), International Journal of Innovative Science and Research Technology , Volume 8, Issue 7, July (2023), DOI: <https://doi.org/10.13140/RG.2.2.12625.30566>
- [8]. UBEH hydrogen Separation Membrane
https://www.ube.com/contents/jp/chemical/separation/hydrogen_separation_membrane.html
- [9]. Global Hydrogen Energy Research Unit, Tokyo Institute of Technology
WebSite
Oxygen hydrogen combustion turbine power generation system
<http://www.ghe.iir.titech.ac.jp/japanese/turbine/index.html>
- [10]. Noriyuki Kodama, Correct D2O Cold Fusion Reactor with Strong Alkaline Electrolyte(Heat Generating Metal Needs to be Anode), International Journal of Innovative Science and Research Technology , Volume 8, Issue 7, July (2023), DOI: <https://doi.org/10.13140/RG.2.2.12625.30566>